

3W가드레일(중분대)(MB-01) SB4등급

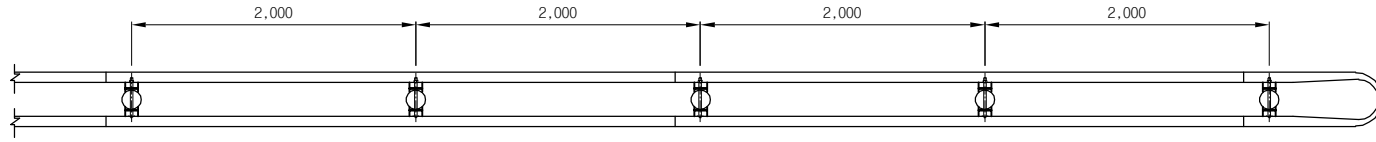

RAIL PLANT
SCALE: NONE

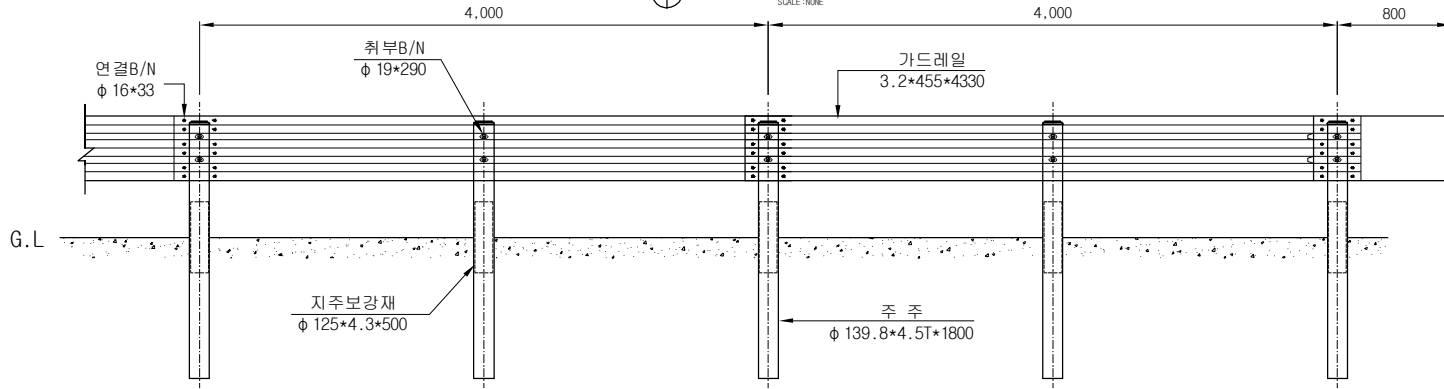

RAIL ELEVATION
SCALE: NONE

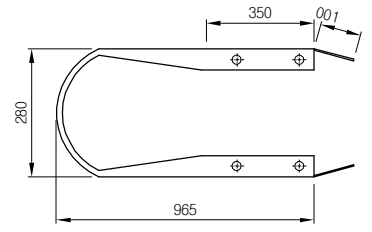

라운드레일
SCALE: NONE

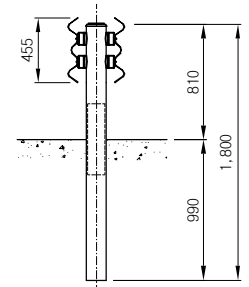

SIDE ELEVATION
SCALE: NONE

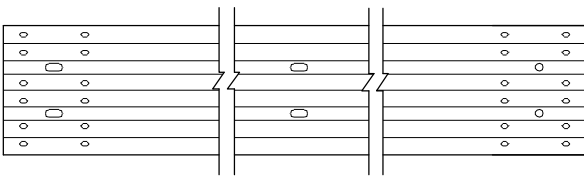

가드레일
SCALE: NONE

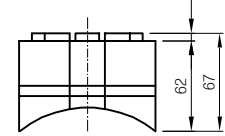
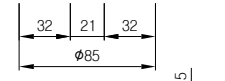
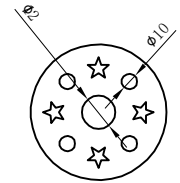
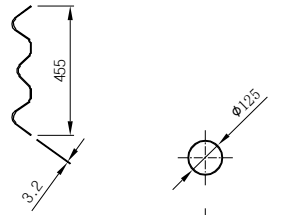

충격흡수판
SCALE: NONE

표준구간(경간당)

(2M/18간)

품명	규격	단위	수량	비고
가드레일	3.2T*455*4330	매	1	용융도금
주주	φ 139.8*4.5T*1800	본	1	용융도금
주주캡	φ 139.8용	EA	1	용융도금
연결B/N	φ 16*33	SET	12	용융도금
취부B/N	φ 19*290	SET	2	용융도금
충격흡수판	φ 85*67	EA	4	RUBBER
지주보강재	φ 125*4.3T*500	본	1	용융도금

단부구간(개소당)

품명	규격	단위	수량	비고
라운드레일	3.2T*455*965	매	1	용융도금
주주	φ 139.8*4.5T*1800	본	0.5	용융도금
주주캡	φ 139.8용	EA	0.5	용융도금
연결B/N	φ 16*33	SET	12	용융도금
취부B/N	φ 19*290	SET	1	용융도금
충격흡수판	φ 85*67	EA	2	RUBBER
지주보강재	φ 125*4.3T*500	본	0.5	용융도금

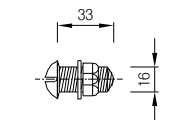

연결볼트
SCALE: NONE

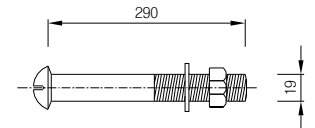

취부볼트
SCALE: NONE

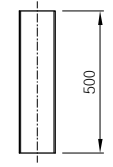

지주보강재
SCALE: NONE

명칭	3W가드레일	등급	SB4	용도	중앙분리대용	모델명	
공사명		날짜		축척		도면번호	