

# 2W 표준 노측용 SB2 (성토부 JISG-2W-RS-02)

## 완충브라켓 상세도

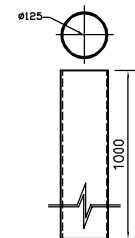
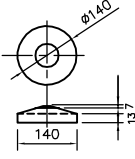
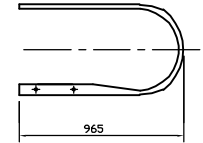
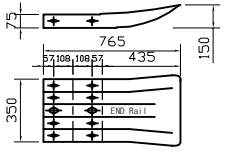
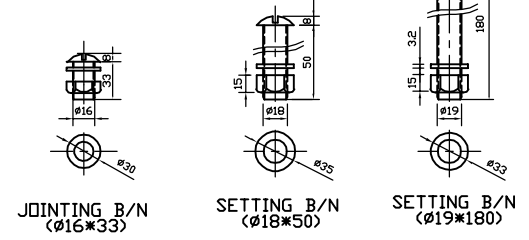
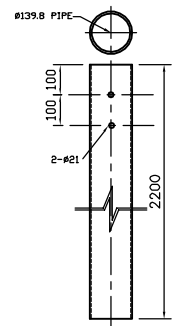
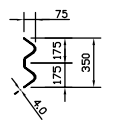
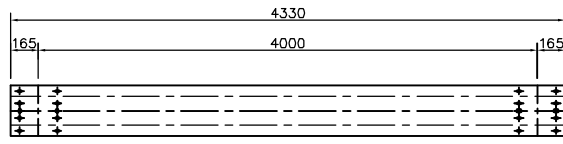
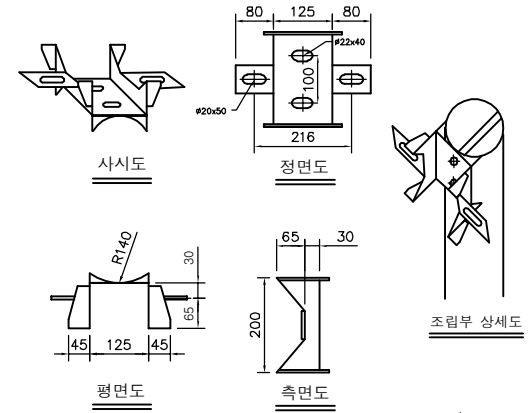
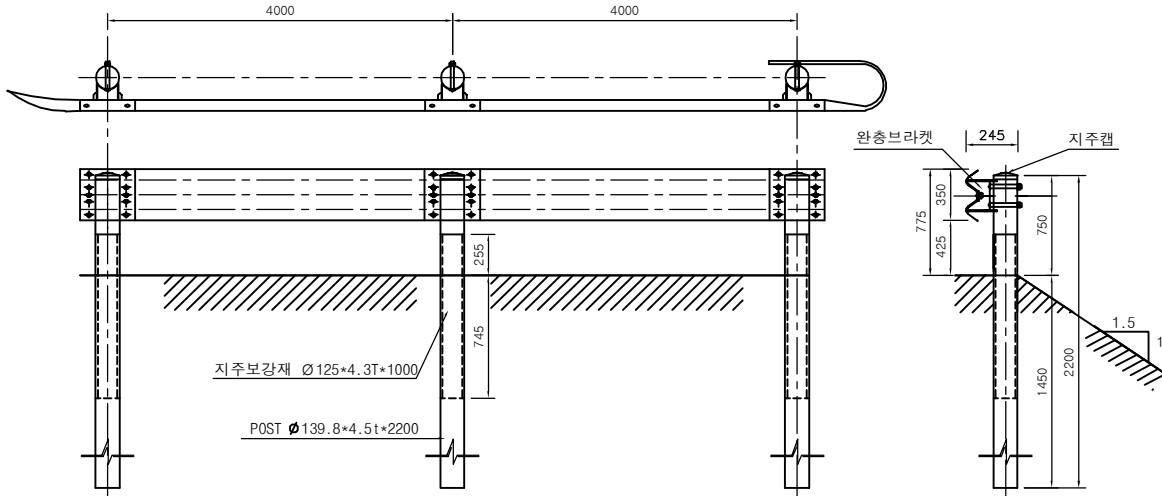

단부레일 상세도

지주캡 상세도

지주보강재상세도

PIPE POST 상세도

### 자재리스트

1경간 (4M)당 재료표

No.	품 목	규 격	단위	수량	재 질	방식처리
1	GUARD RAIL	4.0Tx350x4330	매	1	SS400	용융아연도금 및 분체도장 선택사용
2	PIPE POST	Ø139.8x4.5Tx2200	본	1	STK400	
3	지주 CAP	Ø139.8용	EA	1	SPHC	
4	완충브라켓	3.2Tx125x95	EA	1	SS400	
5	SETTING B/N	Ø19x180	조	2	SS400	
6	JOINTING B/N	Ø16x33	조	8	SS400	
7	SETTING B/N	Ø18x50	조	2	SS400	
8	지주보강재	Ø125x4.3Tx1000	본	1	STK400	

명진공업(주)	도로 안전 부대시설 표준도	REV. No.		도 면	2W 표준 노측용	도 면
		최종작성일	2017. 09.	제 목	SB2 (성토부 JISG-2W-RS-02)	번 호